

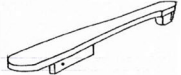











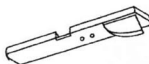
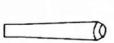

H-D® SKULL ADIRONDACK CHAIR

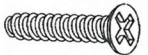
Assembly Instructions

Parts List

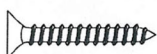
A		83x50.5x4.5cm	1	D		72x12x6.5cm	2
				E		54.5x5x1.5cm	1
B		90.5x50.5x12cm	1	F		18x4x2cm	2
C		51.5x8x9.5cm	2	G		2.6x10cm	2
H		M6 INNVEDIG MUTTER	4	M		M6X14mm	20
I		M6	4	N		6x60mm	4
J		∅ 6x50mm	2	O		8x50mm	2
K		∅ 6x55mm	2	P		M8	2
L		∅ 4x40mm	4	Q		M8X16mm	4

Step 1

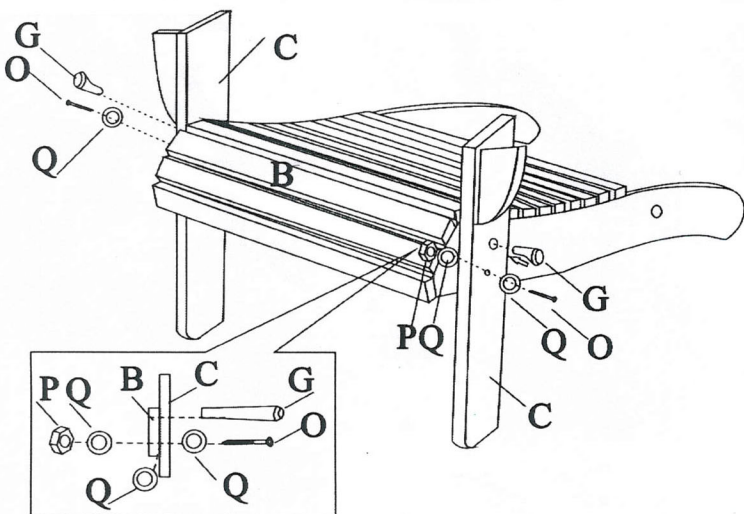

Step 2

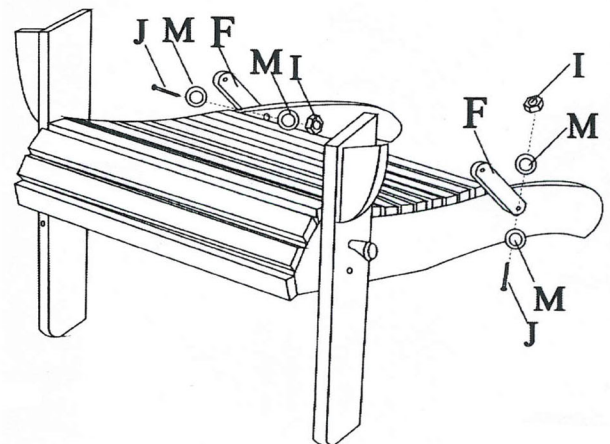

Step 3

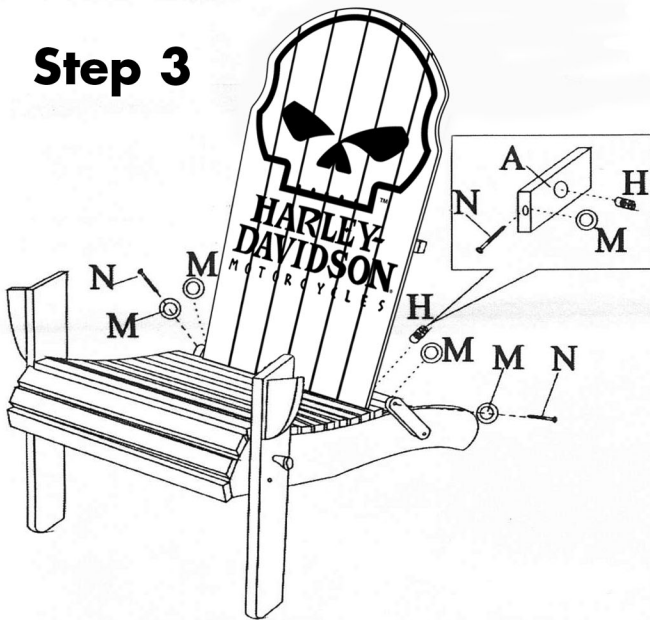

Step 4

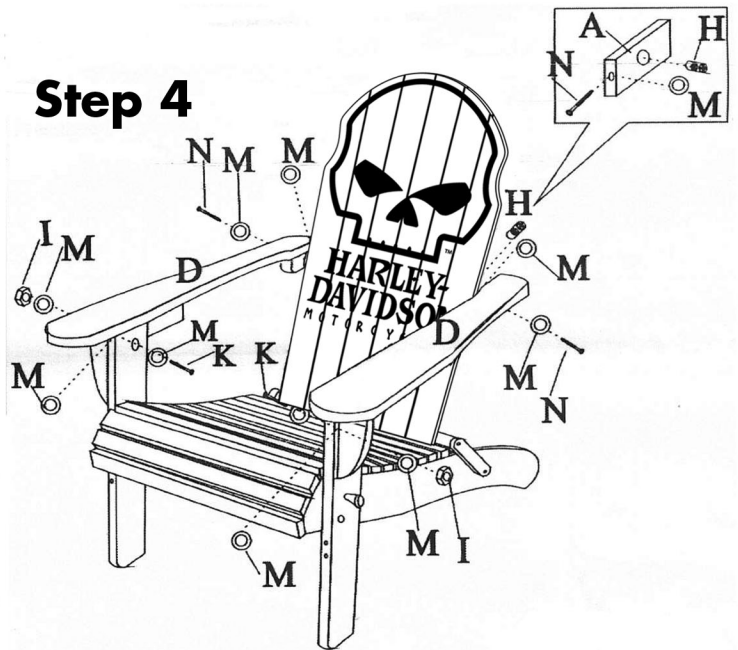

Step 5



Step 6 (Folding chair for storage)

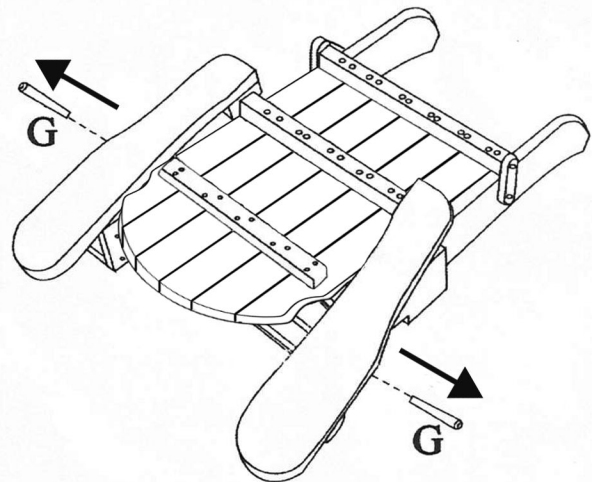

Note: Store Adirondack in a dry location to maximize product life

Warning: Keep sharp objects out of pockets. They can get caught between slats and damage the wood. (250 lb. weight limit.)

Warranty:

Free replacement of any parts that fails within 90 days from date of purchase, excluding shipping costs. Void if damaged by misuse, accidents, alterations, failure o follow instructions, fire, flood and acts of God.

If you have any questions or comments, please contact us at: BrandedProducts.com



HARLEY, HARLEY-DAVIDSON and the Bar & Shield Design are among the trademarks of H-D U.S.A., LLC ©2016 H-D and its Affiliates. All Rights Reserved. Ace Product Management Group, Inc. is a licensee of Harley-Davidson Motor Company. For a dealer near you call toll free 1-800-588-2743 in the USA and Canada or use our dealer locator at www.harley-davidson.com

Ace Product Management Group, Inc. Milwaukee, WI U.S.A.